

■ GECKO | COMPACT WELDING TRACTOR

Gecko is a portable mini fillet welder designed to produce consistent high-quality welds.

It features 4-wheel drive system with magnetic traction and a control loop feedback mechanism which provides speed stabilization in all welding positions.

Constant, continuous and repeatable travel speed enables weld bead geometry that is exact to the required specifications, thus reducing costly over welding and decreasing filler metal usage, substantially.

Lots of optional accessories make Gecko fit for a specific use including cutting and welding of stainless steel constructions.

GECKO compact welding tractor weighs only 8 kg (17 lbs).



42V AC version available

■ Applications:

- Trailer manufacturing
- Truck tanks
- Oil tanks
- Water storage tanks
- Transformers
- Shipyards
- Any application demanding a long, continuous fillet weld



GECKO HS (High Speed)

New special version for specific applications is available now

GECKO HS (High Speed)

with increased horizontal speed up to 220 cm/min (86.6 in/min) is suitable for both speed welding and plasma cutting

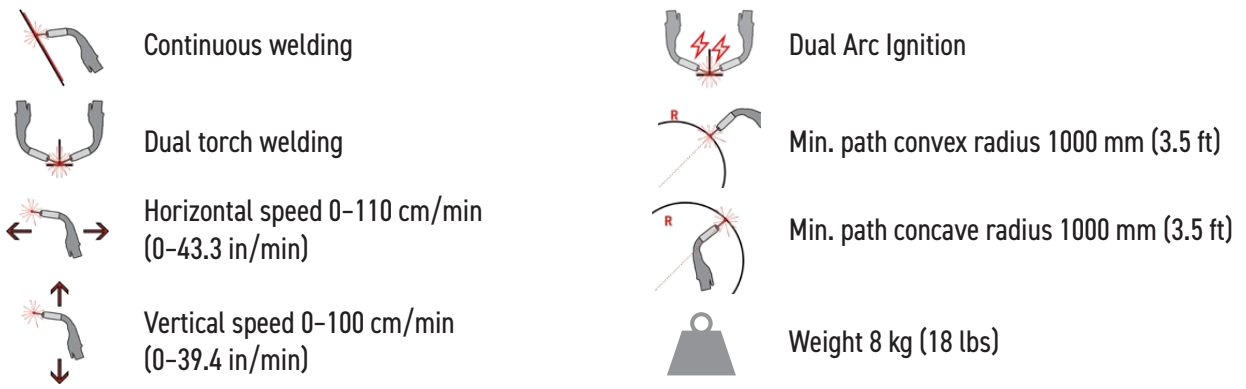

Versatility of Gecko welding tractor applications including out-of-position use

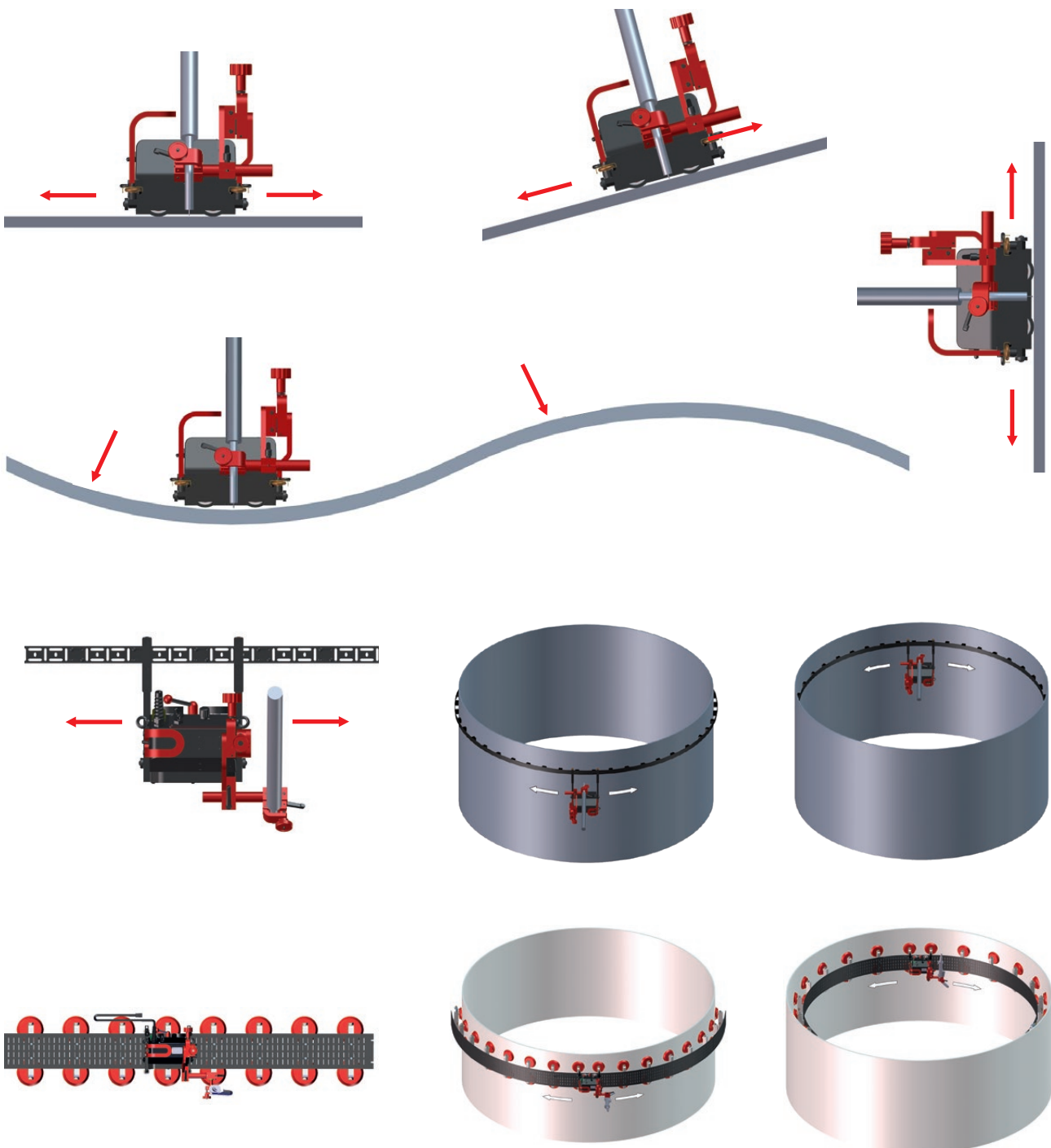

■ Primary features and benefits of Gecko welding tractor:

- Compact, lightweight design with durable aluminum cast housing
- Convenient Power Supply 115-230 V, 50-60 Hz or 42 V, 50-60 Hz
- Positive magnetic traction permits out of position use
- Magnet on/off lever permits easy set up and adjustment on work piece
- Maintenance free 4-wheel drive with worm gear reduction
- Heat resistant silicone wheels
- Quick clamping Torch Holder mechanism for different types of MIG/MAG torches with diameters of 16-22 mm (5/8" - 7/8"); optionally up to 35 mm (1-3/8")
- Precise torch adjustment with screw drive cross slide
- Multifunctional LED display - presetting of travel speed, error codes information
- Closed loop speed control system stabilizes travel speed to reduce weld defects and costly rework
- Consistent heat input reduces distortion
- Reduced wasted filler metal - eliminates over welding
- Automatic arc on/off system initiates welding with travel, simultaneously
- Capable of carrying and controlling 2 torches
- Self-guiding roller arms eliminate the need for track
- Multi-surface guiding with user-friendly adjustment of tractor position
- Improves working environment - removes operator from heat and fumes
- Plasma cutting possible

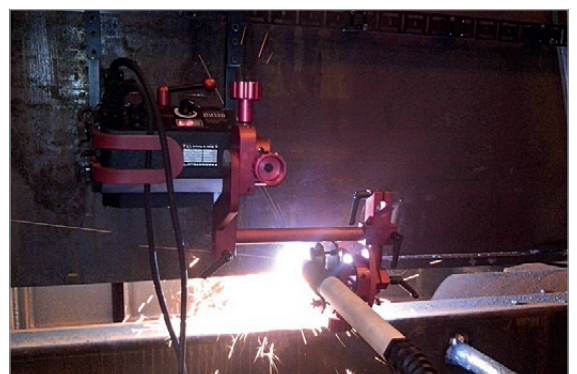
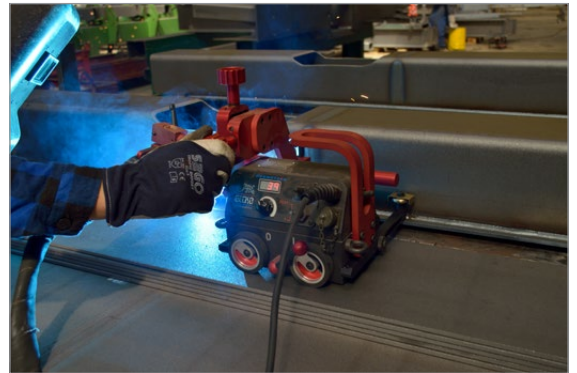

TECHNICAL SPECIFICATIONS	GECKO	GECKO HS
Voltage	1~ 115-230 V, 50-60 Hz 42 V, 50-60 Hz	1~ 115-230 V, 50-60 Hz 42 V, 50-60 Hz
Power	20 W	20 W
Welding position (according to EN ISO 6947 and AWS/ASME)	PA / 1F / 1G PB / 2F PC / 2G PD / 4F PE / 4G PG / 3F / 3G (contact dealer)	PA / 1F / 1G PB / 2F PC / 2G PD / 4F PE / 4G
Torch diameter	16-22 mm (0.63-0.87"); up to 35 mm (1.38") option	16-22 mm (0.63-0.87"); up to 35 mm (1.38") option
Minimum radius of curved workpiece surface	1000 mm (3.5 ft)	1000 mm (3.5 ft)
Minimum workpiece thickness	4 mm (0.16")	4 mm (0.16")
Ground clearance	4 mm (0.16")	4 mm (0.16")
Horizontal pulling force	150 N	150 N
Vertical pulling force	100 N	N/A
Cross slide adjustment range	0-35 mm (0-1.38") up down, left-right	0-35 mm (0-1.38") up down, left-right
Horizontal speed	0-110 cm/min (0-43.3 in/min)	5-220 cm/min (1.5-86.6 in/min)
Vertical speed	0-100 cm/min (0-39.4 in/min)	N/A
Weight	8 kg (18 lbs)	8 kg (18 lbs)
Welding settings storage	1 (last used)	1 (last used)
Product Code (115-230 V, 50-60 Hz, plug EU)	WOZ-0466-10-20-00-0	WOZ-0528-10-20-00-0
Product Code (115-230 V, 50-60 Hz, plug UK)	WOZ-0466-10-10-00-0	WOZ-0528-10-10-00-0
Product Code (42 V, 50-60 Hz)	WOZ-0621-10-04-00-0	WOZ-0622-10-04-00-0

Dimensions:

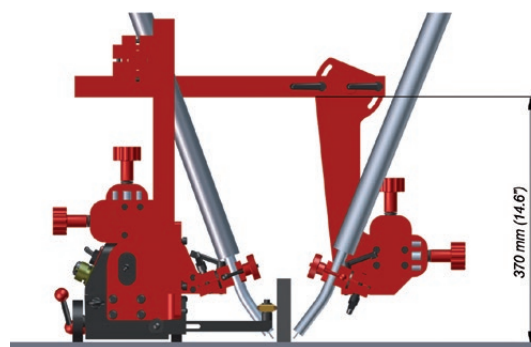
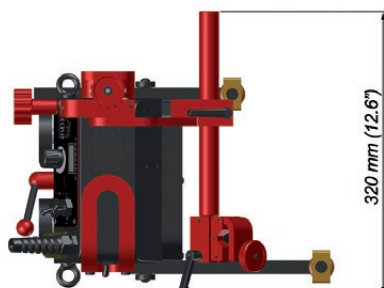
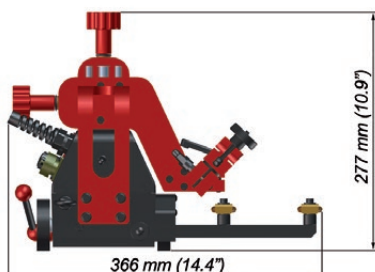

1. Drive unit with control panel
2. Magnetic adhesion release lever
3. Weld contact / Arc ignition socket
4. Power supply coupling
5. Adjustable guide arm
6. Quick clamp torch holder
7. Main power switch (0/1)
8. Cross slide assembly



The newest improved guide arms family makes a proper welding tractor positioning even easier.

- 7 different guide types are dedicated to various welding applications and positions
- include a number of fixing grooves for your convenience
- enable simpler, easier and more consistent adjustment of how guide arms stick out
- secure proper tilting of the tractor into a direction of its movement
- maintain a permanent contact with the workpiece
- allow either interval or continuous guide arms adjustment

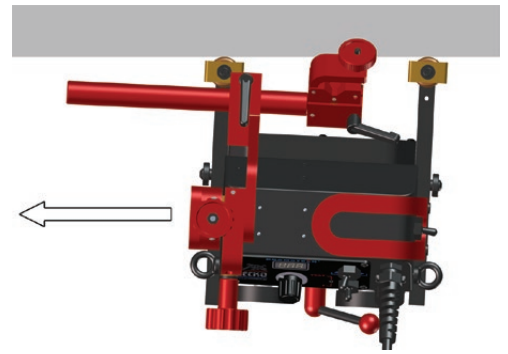

Each new guide arm has got a number of indented grooves only on one side.

All types of guide arms are available in pairs of 2 pcs: right and left.

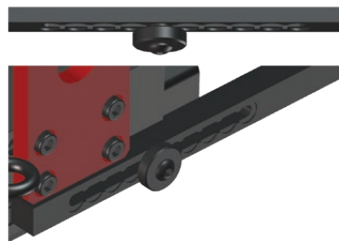

Interval adjustment of a degree how much the guide arms stick out

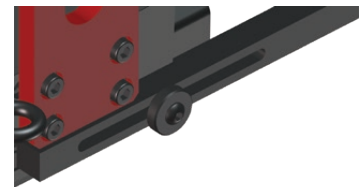

Continuous adjustment of a degree how much the guide arms stick out

■ Standard accessories



Standard guide arms (set of 2 pcs)
PRW-0466-67-00-00-0

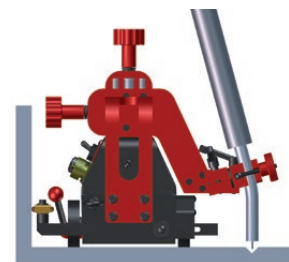
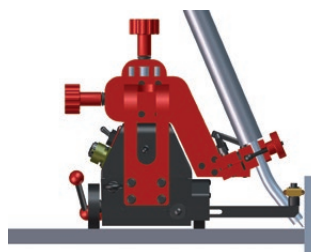

Power cord 3 m (10 ft)
PWD-0466-18-00-00-0 (230 V CEE)
PWD-0466-16-00-00-0 (115 V USA)
PWD-0466-23-00-00-0 (115 V UK)



Dual arc ignition cable of 6.5 m (21 ft)
KBL-0466-17-00-00-0



Torch Holder Long Rod Clamp Assembly
UCW-0466-04-00-00-0

Optional accessories for variety of applications

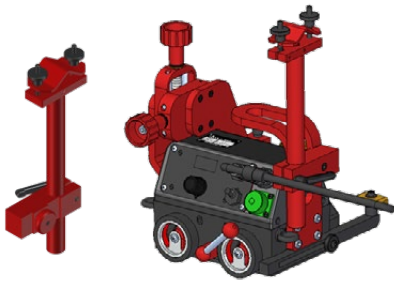

Cable anchor
PDT-0466-55-00-00-0

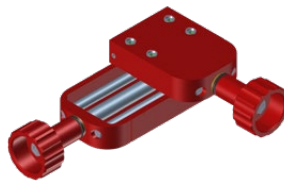

Extended cross-slide
0-76 mm (0-3") up-down,
0-35 mm (0-1.38") left-right
ZSP-0466-46-00-00-1



Torch Extension Arm
PRD-0466-43-00-00-0



Fall arrester device
URZ-000001

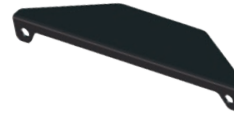

Display shield
OSL-0466-29-00-00-0

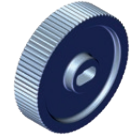

Stainless steel driving wheel
KOL-0466-72-00-00-0



Dual Torch Mount
PDT-0466-40-00-00-0

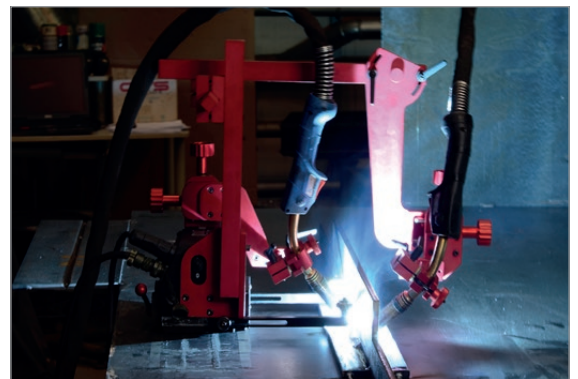
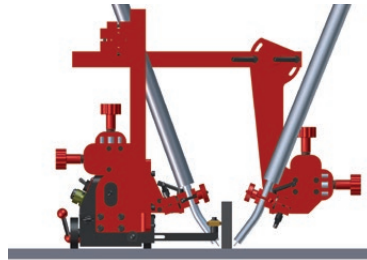

Short Rod Clamp
WLK-0476-20-01-00-0



Magnet blocks (front)
M5x25
BLO-0466-44-01-00-0



Magnet blocks (front) with
increased power M5x25
BLO-0466-47-01-00-0



Torch clamp 22-35 mm
ZRZ-0466-19-00-00-0



Magnet blocks (back) M6x25
incl. additional spacer plate
required for Gecko Battery only
BLO-0466-45-01-00-0

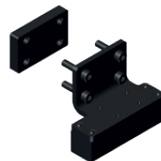

Magnet blocks (back) with
increased power M6x25
BLO-0466-48-01-00-0

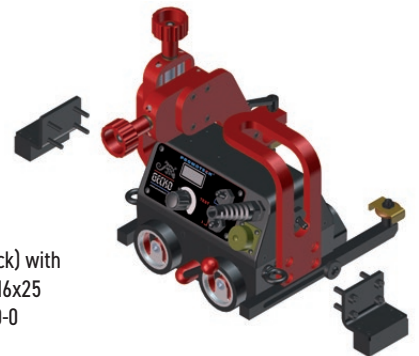

Optional accessories for multi-surface guiding and variety of applications



Low guide arms (set of 2 pcs)
PRW-0466-65-00-00-1

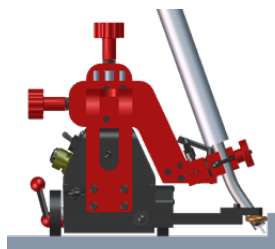



High guide arms (set of 2 pcs)
PRW-0466-66-00-00-1

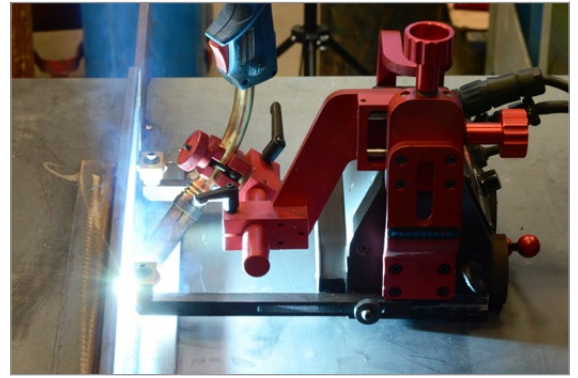
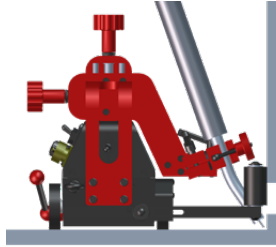

Edge following guide arms (set of 2 pcs)
PRW-0466-41-00-00-1

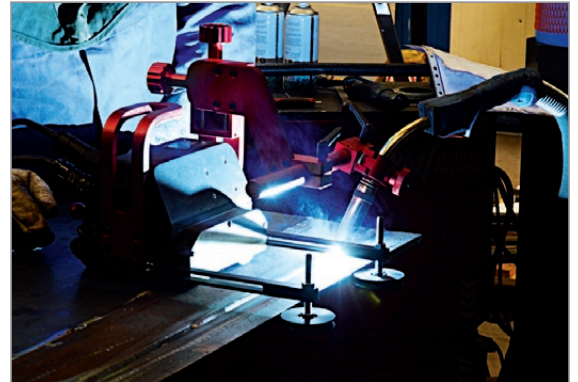
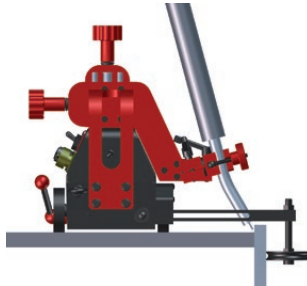

Adjustable guide arms (set of 2 pcs)
PRW-0466-42-00-00-1

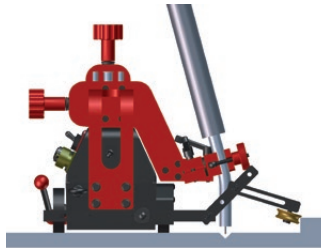

Magnet guide arms (set of 2 pcs)
PRW-0466-52-00-00-1

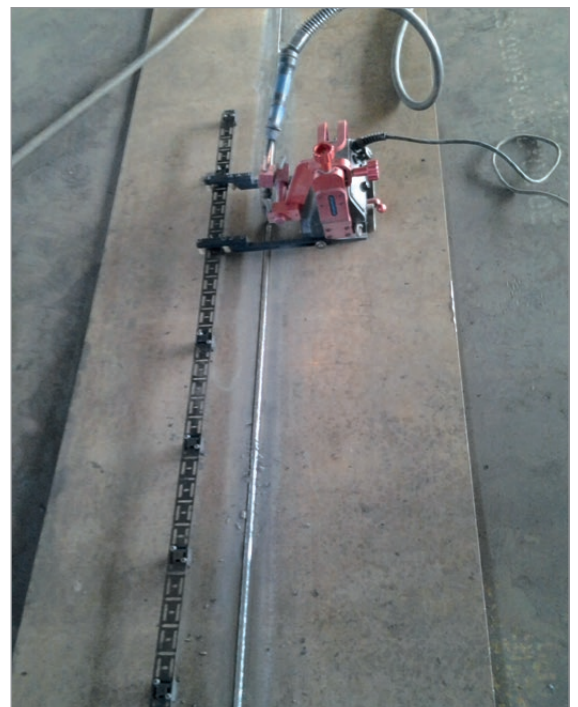

Track following guide arms (set of 2 pcs)
PRW-0466-50-02-00-1

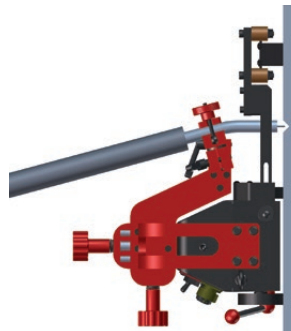

Guide adjustment tool to position the
track parallel to the edge
UST-0466-53-00-00-0

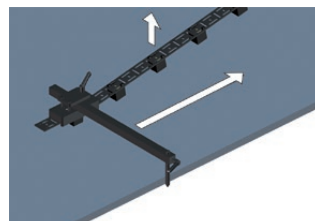

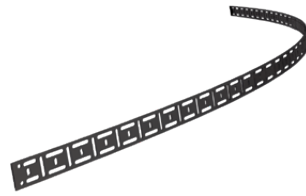

Flexible track length 185 cm (6ft) 1pc
Minimum curvature radius of 1.0 m (3.3 ft)
PRW-0466-50-01-01-0



Magnetic block for flexible track
box of 10 pcs
BLO-0466-68-00-00-0

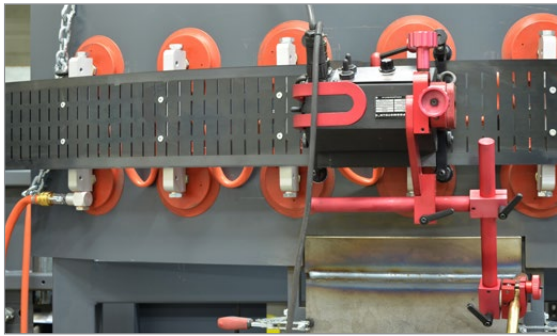

Depending on sort of fixing units in use with flexible trackway, Gecko and Gecko HS welding tractors are suitable for applications with carbon steel, stainless steel and aluminum.

Flexible trackway length 1.88 m (6.1 ft).
Minimum curvature radius of 1.25 m (4.1 ft)
PRW-0466-71-00-00-0

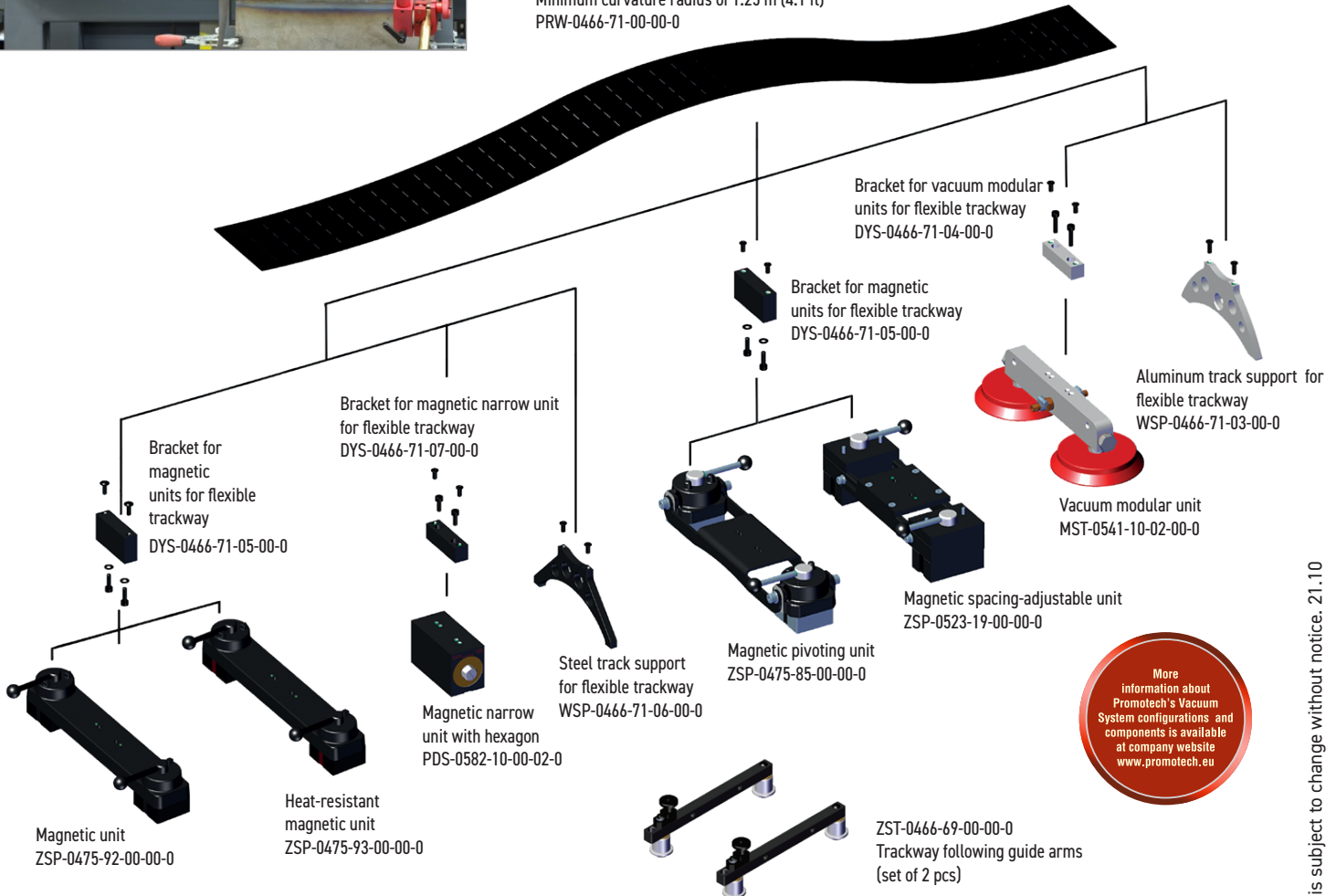

More information at www.promotech.eu



All information is subject to change without notice. 21.10



PROMOTECH Sp. z o.o.
ul. Elewatorska 23/1, 15-620 BIAŁYSTOK, POLAND
tel. (+48 85) 678 34 05, fax (+48 85) 662 78 77
marketing@promotech.eu www.promotech.eu

Your local dealer:

